

MFT

5 function Multirange Multivoltage timer

MFT offering 5 classic different functions to meet the varied time control needs for controlling such applications as fans, pumps and lighting. By having a flexible supply voltage and flexible time range, the MFT relay can be easily applied to many control applications designed to meet the requirements of panel building, the status of supply voltage; time sequence and output relay is visible on the front by LED indicators All rotary adjustment buttons are located on the front.



General specifications

- Main Standards: IEC 61812-1, IEC 61000-6-2, EN 50178
- Additional standards: IEC 61000-4-2, IEC 61000-4-3, IEC 61000-4-4, IEC 61000-4-5
- Protection class open air: IP20
- Protection class enclosed (accessible front): IP40
- Self-extinguishing plastic housing UL V0 acc IEC 529
- Mounting position: on DIN-rail TS 35 according to EN 50022
- Mounting position: vertically
- Terminal : acc IEC 60947-7-1, IEC 60998-1
- Terminal Capacity: 1x4mm² without multicore cable end
1x0.5 to 2.5mm² with/without multicore cable end

Display

- Power on: LED green (Un) Indicates of supply voltage
- Relay energized: LED red (R) indicates of relay energized.

Incoming supply circuit

- Supply tolerance: ± 10%
- Rated power consumption: 2 VA
- Rated frequency for as voltage: 48 to 63 Hz
- Duty cycle: 100%
- Reset time: 30 ms
- Drop off voltage: ≥ 15% of nominal voltage.

Environmental conditions

- Permissible ambient temperature: -25°C....+55°C
- Storage temperature: -25°C....+70°C
- Transport temperature: -25°C....+70°C
- Relative humidity (acc. IEC 721-3-3 CLASS 3K3): 15% to 85%
- Vibration resistance (acc. IEC 68-2-6): 10 TO 55 H

Accuracy

- Base accuracy at min. and max scale: ±1%
- Adjusting accuracy: <5% of max scale value
- Repetition accuracy under constant condition: <0.5% (as % of full range)
- Voltage influence: No
- Temperature influence: < 0.01% / °C

Output circuit

- Relay: 1 C/O
- Rated voltage: 250 Vac
- Switching capacity ac: 2000 VA (8A / 250V) COS φ = 1
- Switching capacity dc: 3 A 30 Vdc
- Max switching capacity ac: 10 A
- Mechanical life: 1 x 10⁶ operations
- Electrical life at 1000 VA COS φ =1: 200.000 operations

Dimensions & weight

- Width: 18 mm
- Height: 89 mm
- Depth (excl. DIN-profile): 64 mm
- Weight: 67 gram

Timing

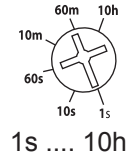

Ordering information

MFT - V	400VAC
	120VAC
	110VAC
	24VAC
	24VCD

Functions

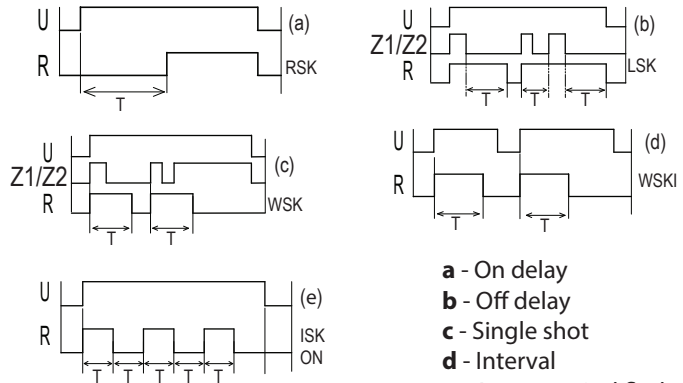

- a** - On delay
- b** - Off delay
- c** - Single shot
- d** - Interval
- e** - Asymmetrical flasher

Dimensions

